



record FlipFlow WIDE

User manual

Document identification

Article nr.: 121-006454502
Version: 2.0
Publication date: 17/09/2024

Translation of the original manual

Subject to technical modifications
Copyright © agtatec ag

Table of contents

List of changes	5
1 Safety	6
1.1 Presentation of warning signs	6
1.2 Intended purpose of use	6
1.3 General hazards	6
1.4 State of technology	9
1.5 Personal protective equipment	9
1.6 Spare parts and liability	10
2 General information	11
2.1 Purpose and use of the instructions	11
2.2 Copyright	11
2.3 Product identification	11
2.4 Manufacturer	11
2.5 Target groups	11
2.6 Definition of terms	12
3 Description	13
3.1 Product overview	13
3.2 General Description	14
3.3 Safety features and controls	14
3.3.1 Operating unit	14
3.3.2 iPort	14
3.3.3 Traffic lights	14
3.3.4 BDE-Lock key switch	14
3.3.5 Emergency open button (options)	15
4 Specifications	16
4.1 Dimensions	16
4.2 Electrical inputs and connections	17
5 Operation	18
5.1 Menu	18
5.2 Performing a reset	19
5.3 Lock the operating unit	20
5.4 Operating modes and functions	20
5.4.1 CLOSED and LOCKED operating mode	20
5.4.2 OPEN operating mode	20
5.4.3 FLOW operating mode	21
5.4.4 MAINTENANCE mode	21
5.4.5 Function in case of power failure (POWER-UP)	21
6 Inspection and maintenance	22
6.1 General remarks	22
6.2 Operator duties	23
7 Malfunctions	25
7.1 Status displays	25
7.2 Error displays	25
7.3 Examples of errors / alarms	25
7.3.1 Power failure	25
7.3.2 Disturbance alarm	25
7.3.3 Technical alarm	26
7.3.4 Intrusion alarm	26

Table of contents

7.3.5	Anti-pass-back alarm	26
7.3.6	The difference between anti-passback and intrusion.....	26
8	Taking out of service and disposal	27
8.1	Decommissioning.....	27
8.2	Dismantling and disposal	27

List of changes

Change	Location
Complete revision of all Sections and content	Entire document
New Section structure	Entire document
Revision of all graphics	Entire document

1 Safety

1 Safety

1.1 Presentation of warning signs

Various symbols are used in this guide for easier understanding:



NOTICE

Useful advice and information to ensure correct and efficient workflow of the system.



CAUTION

Against a potential hazardous situation that can lead to minor personal injury and property damage.



WARNING

Against a latent hazardous situation that can lead to severe injuries or death and cause substantial property damage.



DANGER

Against an imminent hazardous situation that can lead to severe injury or death.



DANGER

Against an imminent or latent hazardous situation that could lead to electric shock and cause serious injury or death.

1.2 Intended purpose of use

The system is designed exclusively for use as a pedestrian passage. The installation must only occur in dry areas. If there are deviations, then proper waterproofing and water drains will be required on site.

Any other application or use beyond this purpose is not considered to be an intended purpose. The manufacturer bears no liability for any resulting damage; the operator alone shall bear the associated risk.

The intended purpose also includes observation of the operating conditions specified by the manufacturer, in addition to regular care, maintenance and repair.

Interventions in or alterations to the installation performed by non-approved maintenance technicians exclude the manufacturer's liability for consequential damages.



NOTICE

The operation of an automatic door in combination with a wicket door must only take place if the latter is in a secured position.

1.3 General hazards

The following section lists hazards that can be caused by the system even when used as intended.

To reduce the risk of malfunction, damage to property or injury to persons and to avoid dangerous situations, the safety instructions listed here must be observed.

The specific safety instructions in the other sections of this manual must also be observed.



DANGER

Electric Shock!

In case of contact with live parts, there is an immediate danger to life due to electric shock. Damage to or removal of the insulation or individual components can be life-threatening.

- a) Before starting work (cleaning, maintenance, replacement) on active parts of electrical systems and equipment, ensure that all poles are voltage free and that this is maintained for the duration of the work.
- b) Keep moisture away from live parts. This can lead to a short circuit.
- c) Never bridge fuses or put them out of operation.
- d) Do not connect the power supply until all work has been completed.
- e) Have work on the electrical system performed by qualified personnel only.



DANGER

Serious or fatal injuries!

If safety devices of the fire protection system do not function properly, there is a risk of serious or fatal injuries.

- a) Never disconnect the fire protection system from the power supply overnight.
- b) Do not disassemble, put out of operation or manipulate safety devices.
- c) Do not remove safety instructions on the system.
- d) Never block, hold open or otherwise prevent fire doors from closing.
- e) Have inspection, service and maintenance of the fire protection system carried out in accordance with locally applicable regulations or according to a maintenance contract.
- f) Have the fire protection system checked and maintained according to the state of the art.



WARNING

Serious injuries and major material damage.

Incorrect mounting can lead to serious injuries and/or cause major material damage.

- a) Observe and comply with all important instructions regarding safe assembly.



CAUTION

Risk of malfunctions, material damage or injuries!

Improper settings can lead to malfunctions, material damage or injuries.

- a) Do not disconnect the system from the power supply overnight.
- b) Settings should only be made by personnel qualified to do so.
- c) Do not disassemble, put out of operation or manipulate safety devices.
- d) Have faults rectified by specialist personnel or by personnel qualified to do so.
- e) Have service and maintenance carried out according to locally applicable regulations or according to a maintenance contract.



CAUTION

Risk of malfunctions, material damage or injuries!

Insufficient or inattentive cleaning or care of the system can lead to malfunctions, material damage or injuries.

- a) Check the sensors regularly for dirt and clean them if necessary.
- b) Regularly remove dirt accumulations in the floor rail or under the floor mat.
- c) Keep the system free from snow and ice.
- d) Do not use aggressive or caustic cleaning agents.
- e) Use road salt or loose chippings only conditionally.
- f) Lay the floor mat without folds and flush with the floor.
- g) Equipment required for cleaning purposes such as ladders or similar must not be leaned on or attached to the system.



CAUTION

Risk of material damage or injuries!

The door can open, close or turn unexpectedly. This may result in material damage or injuries.

- a) No persons may be present in the opening area of the system.
- b) Ensure that moving objects such as flags or parts of plants do not enter the detection range of the sensors.
- c) Do not make any settings on the control unit when the system is in use.
- d) Have faults rectified immediately by specialist or personnel qualified to do so.
- e) Remove objects from the opening area.
- f) Do not disassemble, put out of operation or manipulate safety devices.
- g) Do not rush through a closing system.



CAUTION

Risk of bruising and severing of limbs!

If the system moves, careless behaviour can lead to serious injuries to limbs or severance of limbs.

- a) Do not reach in when parts of the system are moving.
- b) Keep a distance when parts of the system move.
- c) Do not bump into or touch the system when it is moving.
- d) Do not open or remove protective covers during operation.
- e) Do not permanently remove covers from the system.
- f) Only carry out inspection, service, maintenance and cleaning when the system is stationary and switched off.



CAUTION

Risk of material damage or injuries!

If safety devices are not functioning, manipulated or put out of operation, there is a risk of material damage or injuries that can lead to death.

- a) Never disable or manipulate safety devices.
- b) Have inspection, service and maintenance of the safety devices carried out according to local regulations or according to a maintenance contract.



CAUTION

Risk of malfunctions, material damage or injuries!

If unauthorised persons use the system, there is a risk of malfunction, material damage or injuries.

- a) Children under 8 years of age may only use the system under supervision.
- b) Children must not play, clean or maintain the system.
- c) Persons with limited physical, sensory or mental abilities as well as persons with insufficient knowledge or experience may only use the system under supervision or must have received and understood instructions to do so.



NOTICE

The country-specific regulations must be observed and complied with.



NOTICE

To avoid malfunctions, moving objects such as flags or parts of plants must not be allowed to enter the detection range of the sensors.



NOTICE

The installation must be inspected during the function and safety check for imbalance and signs of wear or damage to cables, springs and fastening parts.

The equipment must NOT be used if repair or adjustment work needs to be carried out.



NOTICE

Before work can be started, persons must be barred from the system and the danger area.

1.4 State of technology

The system has been developed in accordance with the state of the art and recognized safety regulations and, depending on the options and dimensions, meets the requirements of the Machine Directive 2006/42/EC.

Nevertheless, hazards to the user may arise if the system is not used as intended.



NOTICE

Installation, commissioning, inspection, maintenance, and repair work must only be conducted by qualified, trained and authorized technicians.

After commissioning or repair work, fill in the check list and give it to the customer for safe keeping.

We recommend obtaining a service agreement.

1.5 Personal protective equipment

Personal protective equipment is used to protect persons from adverse effects on health. Personnel must wear personal protective equipment during the various work activities on and with the system.

Personal protective equipment is explained below:



Hearing protection is used to protect the hearing from noise. As a rule of thumb, hearing protection is compulsory from when normal conversation with other people is no longer possible.



The head protection serves to protect against falling and flying parts and materials. It also protects the head from bumping into hard objects.



Protective goggles protect the eyes from flying parts, dust, splinters or splashes.



Protective gloves are designed to protect hands from friction, abrasions, punctures or serious injury and from burning caused by contacting hot surfaces.



Safety shoes protect the feet from crushing, falling parts and slipping on surfaces. The puncture resistance of the shoes ensures, that pointy objects do not penetrate the foot.



The high-visibility vest is used to make the personnel stand out and therefore to be seen. With improved visibility and attention, the high-visibility vest protects personnel in busy work areas from collisions with vehicles.

Depending on the place of work and the working environment, the protective equipment varies and must be adapted accordingly. In addition to protective equipment for specific work, the work site may require other protective equipment (for example a harness).

In hygiene-protected areas, special or additional requirements of personal protective equipment may be required. These requirements must be considered when choosing personal protective equipment. If there is any uncertainty regarding the choice of personal protective equipment, the safety officer must be consulted at the place of work.

1.6 Spare parts and liability

Reliable and trouble-free operation of the door is only guaranteed when using parts that were recommended by the manufacturer. The manufacturer declines any liability for damages resulting from unauthorized modifications to the door or the use of parts that are not permitted.

2 General information

2.1 Purpose and use of the instructions

These instructions are an integral part of the system and enable efficient and safe handling of the system. In order to ensure proper functioning, the instructions must be accessible at all times and kept in the immediate area of the system.

Although only the male form has been chosen for reasons of better legibility, the information refers to members of both sexes.

The operator must have read and understood the manual before starting any work. The basic requirement for safe working is to follow the safety instructions and the handling instructions. In addition, the local regulations and safety rules apply.

The manual can be handed over in extracts to instructed personnel who are familiar with the operation of the system.

The illustrations are for basic understanding and may differ from the actual presentation. Specific representations are contained in the drawings.



NOTICE

A replacement of the instructions is available from the supplier or on the website.

2.2 Copyright

The copyright of the instructions remain at:

© ASSA ABLOY

It is prohibited to reproduce, distribute or use the manuals for purpose of competition without the written authorization of ASSA ABLOY.

Violation of the here stated copyrights will be prosecuted and fined with compensation of damage.

2.3 Product identification

The nameplate located on the door provides accurate identification of the product.

2.4 Manufacturer

ASSA ABLOY Entrance Systems AB

Lodjursgatan 10

SE-261 44, Landskrona

SWEDEN

2.5 Target groups



CAUTION

Risk of injury!

If unqualified personnel work on the system or are in the danger zone of the system, danger can occur, which can cause serious injuries and considerable material damage.

- a) All work must be carried out by approved personnel only.
- b) Keep unapproved personnel away from danger areas.

This operating manual is intended for the target groups listed below:

- Operating entity of the system:
the person who is responsible for the technical maintenance of this system
- Operator of the system:
the person who operates the system every day and has been suitably instructed

2 General information

2.6 Definition of terms

Term:	Explanation:
System	<p>The term is also used in these instructions as a synonym for the product. Door operators, revolving doors, sliding doors, etc. are referred to as a system.</p> <p>If information in these instructions refers to a specific type, this is shown accordingly in the text.</p>
User	Users are all persons who use the system.
System operator	The respective owner is referred to as the system operator, regardless of whether they operate the system as the owner or pass it on to third parties.
Authorized representative	The authorized representative takes over certain parts of the manufacturer's obligations about fulfilling the requirements of the Machinery Directive. In particular, the authorized representative may also place the system on the market and/or sign EC declarations of incorporation.
Qualified personnel	<p>Qualified personnel are authorized and appropriately trained to perform the following work:</p> <ul style="list-style-type: none">– Disassembly, Assembly, Commissioning, Operation, Audit, Maintenance, Troubleshooting, Decommissioning <p>The qualified personnel have several years of professional experience in the technical field, e.g., as mechanics or machine fitters.</p> <p>The qualified personnel are aware of the residual risks arising from the installation site and, due to their professional training, knowledge, and experience, can carry out the work assigned to them and to independently identify and avoid possible danger points.</p>
Manufacturer	The manufacturer is whoever designs and/or builds machinery or incomplete machinery under the scope of the Machinery Directive.
Life phases	All phases of the system's condition and use are referred to as life phases. This applies from the time the system leaves the factory until it is disposed of.
Personnel	All persons who carry out activities on and with the system are referred to as personnel. Personnel can be, for example, the operator, the cleaning staff, or the security staff. The personnel meet the personnel qualifications required by the manufacturer.
Service technician	Experts and specialists or representative authorized by the manufacturer to perform commissioning, maintenance, and servicing.

3 Description

3.1 Product overview

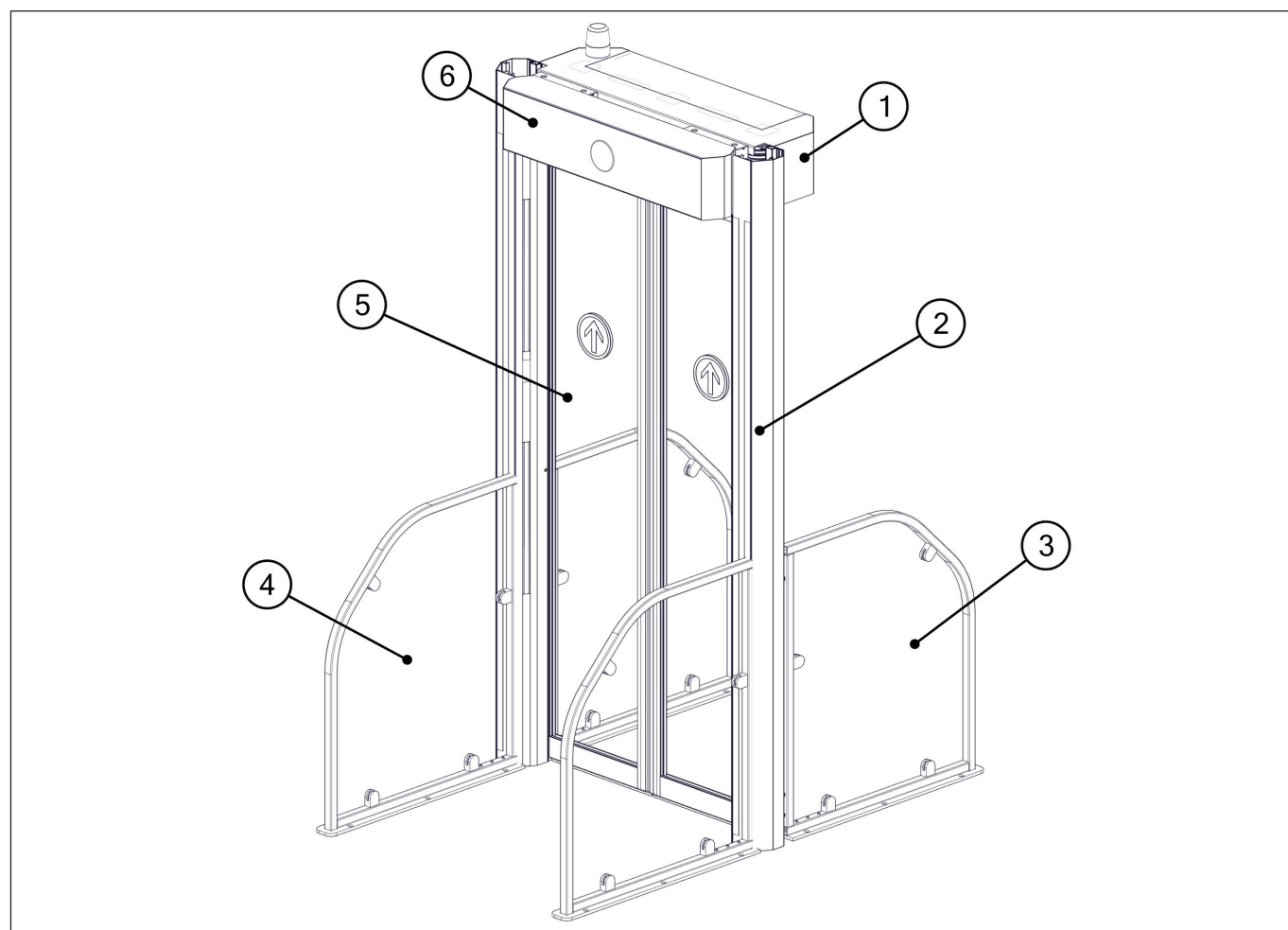

1	Cover exit <ul style="list-style-type: none"> – Sensor – Pictogram (option) – Door leaf drive – Signal light – Control board – Siren (option) 	2	Post <ul style="list-style-type: none"> – Sensor – LED strip (option)
3	Pedestrian guide elements exit	4	Pedestrian guide elements entrance
5	Door leaf	6	Cover entrance <ul style="list-style-type: none"> – Sensor – Pictogram – Door leaf drive – Control unit – Key switch – iPort – Locking

3 Description

3.2 General Description

The system is designed for automatic handling of passenger traffic in and around airports and other security-sensitive buildings. People pass through individually in only one direction and without the possibility of going back in the direction from which they came. The system also prevents uncontrolled access by people coming from a public area to a security zone or a protected area.

Applications:

- At airports between public areas and security zones (e.g. landside/airside)
- For the protection of other security sensitive areas such as ports and railway stations
- For controlling access to public buildings or industrial facilities

3.3 Safety features and controls

3.3.1 Operating unit

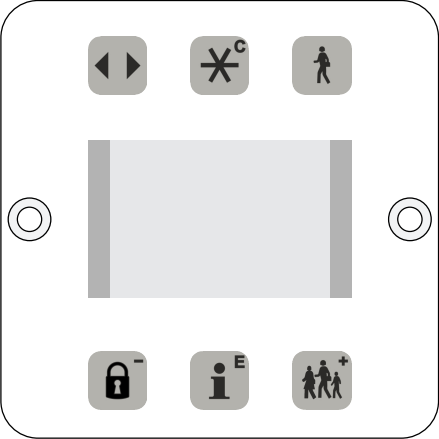
	<p>The BDE-D operating unit is an input and output unit for the operation and limited programming of the system. The display shows information about the system by means of symbols and text.</p>
--	---

3.3.2 iPort

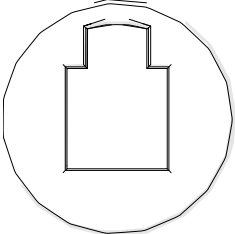
	<p>The iPort is an integrated connection for control and programming devices.</p>
---	---

3.3.3 Traffic lights

The signalling depends on the selected operating mode and the additional functions ordered by the customer. In the basic version, the system has an LED display on the door.

3.3.4 BDE-Lock key switch

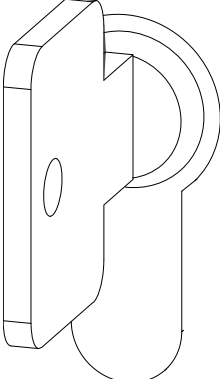
	<p>The BDE-Lock key switch is used to lock or unlock the BDE-D control unit for the door.</p> <p>If the BDE-Lock key switch is turned to blocked, the operating unit is blocked - changes to the operating mode can only be made by unlocking the BDE-Lock key switch.</p>
---	--

3.3.5 Emergency open button (options)

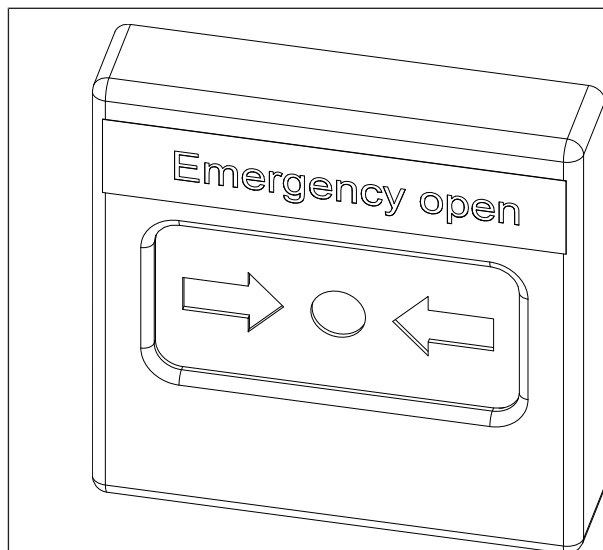

In the event of a system failure or panic, the emergency escape switch can be operated to bring the system into the safety position.

To return to normal operation, the emergency open push button must be reset manually. An acoustic reminder sounds at regular intervals.

However, a command from the BMS to "total opening" always has priority: open both doors.

When the emergency open - middle door (Triple) is actuated, the middle and exit doors open.

When the emergency open - exit door is actuated, the exit door opens, the middle door only if someone is still in tunnel 1.

Status:

- lighting on.
- Entrance door closed and locked.
- LED strip at the entrance red, in the middle (Triple) and at the exit green.
- Pictograms at entrance and exit red.

4 Specifications

4 Specifications

4.1 Dimensions

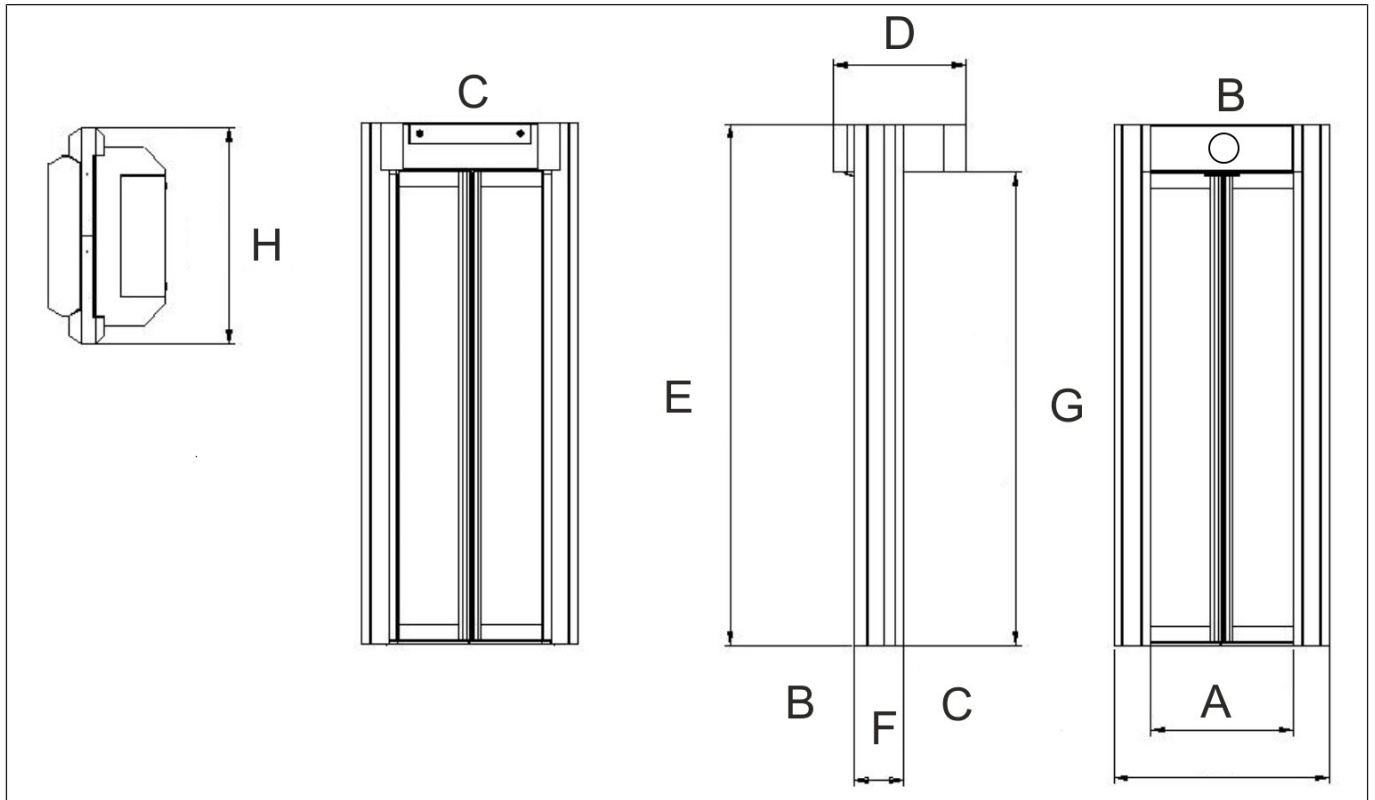

FlipFlow WIDE dimensions (millimetre / inch)

Door type	650	900	1100	1200	1400
A	650 mm / 25.591 in	900 mm / 35.433 in	1100 mm / 43.307 in	1200 mm / 47.244 in	1400 mm / 55.118 in
	A = Passage width				
B	Entrance				
C	Exit				
D	600 mm / 23.622 in				
E	2365 mm / 93.110 in				
F	146 mm / 5,748 in				
G	2150 mm / 84.646 in				
	G = Passage height				
H	980 mm / 38.465 in	1230 mm / 48.307 in	1430 mm / 56.181 in	1530 mm / 60.118 in	1730 mm / 68.110 in

4.2 Electrical inputs and connections



DANGER

Electric Shock!

In case of contact with live parts, there is an immediate danger to life due to electric shock. Damage to or removal of the insulation or individual components can be life-threatening.

- a) Before starting work (cleaning, maintenance, replacement) on active parts of electrical systems and equipment, ensure that all poles are voltage free and that this is maintained for the duration of the work.
- b) Keep moisture away from live parts. This can lead to a short circuit.
- c) Never bridge fuses or put them out of operation.
- d) Do not connect the power supply until all work has been completed.
- e) Have work on the electrical system performed by qualified personnel only.



DANGER

Danger to life in case of faulty installation

- a) There is an immediate danger to life by electric shock when touching live parts. Incorrect installation of individual components can be life-threatening.
 - ⇒ If possible, the wiring for low voltage and mains voltage should be installed in a separate cable duct.
 - ⇒ All wiring must be routed, secured and protected from moving parts, heat sources and sharp edges.
 - ⇒ All electrical components inside the covers, must lie securely or be fixed with adhesive tape.



NOTICE

Electrical inputs are located on the control unit. Inputs for the power supply line are available at each column.



NOTICE

If several systems are installed in parallel, the power supply must be provided via the floor on the two outer columns.



NOTICE

The building management system cables can also be connected via the floor. However, they must never be connected to the 115 / 230 VAC supply cables.



NOTICE

The system is designed for a fixed connection to the electrical supply network. Proper earthing must be provided and the cabling must comply with local regulations.

Electrical data: 115 / 230 VAC / 50-60 Hz / 250 watts | 1 Phase / 3 Wires

Mains voltage:	115-230 VAC
Frequency:	50-60 Hz
Power consumption:	max.: 250 watts

5 Operation

5 Operation

5.1 Menu



NOTICE

The keys on the operating unit are used to set the operating modes in the main menu and the system parameters in the submenu.







The functions of the keys differ from the main menu to the submenu.

Main menu				
Key	Name	Operation	Function	Display example
	Open	Press key 1 x	Open, sensors deactivated	
	Star	Without function	Without function	
	Interlock	Press key 1 x	Monitoring from both directions	
	Locked	Press key 1 x	Door closed, sensors deactivated	
	Info	Restart control unit Press the key for 5 seconds	Restart control unit	
		Restart hardware operating unit Press the key for 12 seconds	Restart hardware operating unit	
		Press key 2 x	Access to parameter menu	
	Flow	Press key 1 x	Monitoring from both directions	



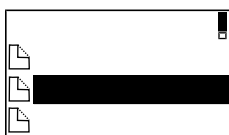

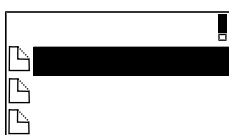



NOTICE

The return from the submenu to the main menu takes place automatically 3 minutes after the last entry.

Submenu				
Key	Name	Operation	Function	Display example
	Enter	Press the key 1 x to access the next submenu.	Select menu item (ex: error, status, parameter), confirm entry	
	Plus	Press the key 1 x to move down.	Navigation down in the menu	
	Minus	Press the key 1 x to move upwards.	Navigation upwards in the menu	
	Clear	Press the key 1 x to return to the previous menu	Exit menu item without saving	

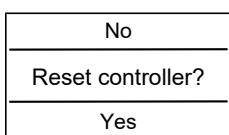
5.2 Performing a reset

Reset of the operating unit				
Step	Key	Operation	Function	Display example
1.		Press key for 12 seconds	Reset the operating unit (connection is established)	

Reset the control system				
Step	Key	Operation	Function	Display example
1.		Press key for 5 seconds	Reset the control system	
2.		Press key 1 x	Cancel reset	
		Press key 1 x	Performing a reset	



5 Operation

5.3 Lock the operating unit



NOTICE

If the key switch BDE-Lock is turned to blocked, the operating unit is locked. Alternatively, the operating unit can be locked via the keyboard.

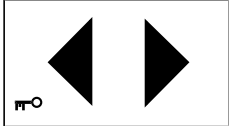
Activate operation lock via keyboard			
Key	Operation	Function	Display example
  	Press the key sequence as shown To deactivate, press the key sequence again	No settings can be made on the operating unit.	

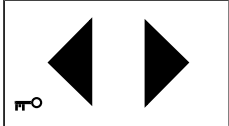
Activating the operation lock with the key			
Prerequisite	Operation	Function	Display example
The desired operating mode is set.	Activate/deactivate the operating lock with the key	No settings can be made on the operating unit.	

5.4 Operating modes and functions

5.4.1 CLOSED and LOCKED operating mode

	Also serves as a manual reset Status: <ul style="list-style-type: none"> - Illumination is off. - LED-Strips and pictograms are red. - Door is closed and locked.
---	---

5.4.2 OPEN operating mode



NOTICE

If the sensor monitoring is deactivated, it is possible to cross the door system in both directions without triggering an alarm.

If the sensor monitoring is activated, the door system can be crossed only in the permitted direction. Otherwise, an alarm will be triggered.

	Status: <ul style="list-style-type: none"> - Lighting on. - Door open. - LED strips at entrance green. - Pictogram at entrance green.
---	---

5.4.3 FLOW operating mode

**NOTICE**

FLOW mode offers a wide variety of passage possibilities as there are no restrictions for the door to open simultaneously, although maintaining a certain level of security thanks to a very low response time of the anti-pass-back system.



Initial state:

- Lighting on.
- Door closed.
- LED strips at entrance green.
- Pictogram at entrance green.

Cycle:

- A person arrives in front of the entrance sensor, the door opens.
- The person enters, the door closes again (if another passenger arrives, the door stays open).
- End of cycle.

5.4.4 MAINTENANCE mode

**NOTICE**

This operating mode allows the service technician access without triggering an alarm. This function can be activated with a local key switch provided by the customer.

Status:

- Illumination is on.
- LED-Strips are yellow.
- Entrance pictograms are red.
- Door is open.

5.4.5 Function in case of power failure (POWER-UP)

**NOTICE**

With battery (optional): Depending on the setting of the parameters, the door closes and locks or opens and unlocks. The unit remains in the corresponding position until the power supply is restored.

Without battery: The system remains in the current position until the power supply is restored.

6 Inspection and maintenance

6 Inspection and maintenance

Regular inspection and maintenance of the system by trained and authorized personal from the manufacturer, is the best guarantee for long life and trouble-free secure operation.

These control and maintenance operations are required at regular intervals, following the manufacturer's instructions and the relevant legal requirements.

6.1 General remarks



DANGER

Electric Shock!

In case of contact with live parts, there is an immediate danger to life due to electric shock. Damage to or removal of the insulation or individual components can be life-threatening.

- a) Before starting work (cleaning, maintenance, replacement) on active parts of electrical systems and equipment, ensure that all poles are voltage free and that this is maintained for the duration of the work.
- b) Keep moisture away from live parts. This can lead to a short circuit.
- c) Never bridge fuses or put them out of operation.
- d) Do not connect the power supply until all work has been completed.
- e) Have work on the electrical system performed by qualified personnel only.



NOTICE

Specific inspections and maintenance may only be carried out by a specialist or a person trained for this purpose. The authorization of these persons is carried out exclusively by the manufacturer. The scope, result and time of the periodic inspections and maintenance must be recorded in an inspection book and a checklist. These documents must be kept by the operator.



NOTICE

The testing and/or servicing interval according to the manufacturer's specification is at least 1 to 2 times a year.



NOTICE

The recommended and planned spare and wear parts can be requested from your service centre.

According to current legislation, the operator of an automatic door system is responsible for its maintenance and safety.

With the care of the installation by the operator, accidents or defects can be avoided.

Testing

Type of test	Action
Visual inspection	Check door leaves, guides, bearings, limiting devices, sensors, and the securing of crushing and shearing points for damage.
Mechanical inspection	Check fastenings for tight fit.
Safety check (exit and escape routes)	Check sensors, safety devices, and monitoring devices for tight fit and damage.
Function testing	Check functioning of switches, operators, controllers, power or energy storage devices, and sensors. Also check the adjustment of the safety devices and the setting of all movement sequences including the end points.
Test run	Final overall review is carried out.

Servicing

Type of servicing	Action
Adjustment and cleaning	Clean and adjust bearings, sliding points, and power transmission. Check relevant fastening screws and retighten if necessary.

For documentation and information purposes, the testing and servicing work as well as the condition of the system are recorded in a test log book. The test log book must be kept for at least one year or until the next testing/servicing.

6.2 Operator duties

Personal protection requires compliance with the standards and guidelines for publicly accessible facilities.

The system operator is responsible for carrying out testing and servicing.



NOTICE

The system must be inspected by an expert before initial commissioning and subsequently according to the manufacturer's instructions or at least once a year.



NOTICE

The installation must be inspected during the function and safety check for imbalance and signs of wear or damage to cables, springs and fastening parts.

The equipment must NOT be used if repair or adjustment work needs to be carried out.

6 Inspection and maintenance



CAUTION

Risk of malfunctions, material damage or injuries!

Insufficient or inattentive cleaning or care of the system can lead to malfunctions, material damage or injuries.

- a) Check the sensors regularly for dirt and clean them if necessary.
- b) Regularly remove dirt accumulations in the floor rail or under the floor mat.
- c) Keep the system free from snow and ice.
- d) Do not use aggressive or caustic cleaning agents.
- e) Use road salt or loose chippings only conditionally.
- f) Lay the floor mat without folds and flush with the floor.
- g) Equipment required for cleaning purposes such as ladders or similar must not be leaned on or attached to the system.

Tasks system operator

Task	Personnel	Time of implementation	Entry in the inspection book
Maintenance and cleaning of the sensors for safety and triggering	System operator	Weekly, or as required	No
Function and safety check	System operator	Monthly	No

Tasks of qualified person

The inspection is carried out according to the manufacturer's test instructions.

The inspection usually takes place at the same time as the maintenance of the system.

The inspection also checks whether no changes have been made to the system since the last inspection and whether it meets the current safety requirements.

Task	Personnel	Time of implementation	Entry in the inspection book
Acceptance test	Qualified person	After assembly of the door system ready for operation	Yes
Servicing	Qualified person	1 x annually, or according to country-specific standards and guidelines	Yes
Test (inspection)	Qualified person	1 x annually, or according to country-specific standards and guidelines	Yes

7 Malfunctions

7.1 Status displays



NOTICE

The status display shows information with status number and message in plain text. If there is more than one piece of information (e.g. malfunction), the number and the consecutive entry number are also displayed.

The next entry is called up by pressing the info key.

Key	Operation	Function	Display example
	Press key 1 x	Change of information if several messages are pending Return to main menu for 4 seconds, then display of information again	

7.2 Error displays

Key	Operation	Function	Display example
	Press key 1 x	The current errors in the error display are shown as a list of error numbers without plain text display in decimal format. The error number is composed of the error source and the error number. Up to three error codes can be listed per display. If there are more errors, the number of displays and the current display number are also shown. The next page is called up by pressing the info key.	

7.3 Examples of errors / alarms

7.3.1 Power failure



NOTICE

With battery (optional): Depending on the setting of the parameters, the door closes and locks or opens and unlocks. The unit remains in the corresponding position until the power supply is restored.

Without battery: The system remains in the current position until the power supply is restored.

7.3.2 Disturbance alarm



NOTICE

Below you will find a list of situations in which an alarm (buzzer) can be triggered due to a disruption in the pedestrian flow. Time delays are programmed for the delayed triggering of the corresponding alarms.

	<ul style="list-style-type: none"> – A person or an object is standing/lying in zone 2a or 2b; the door system is closed. – A person or an object is standing/lying in the door system or in zone 2a and/or 2b; the door system is open. – The door is no longer in one of its end positions. – The door system is not open (or closed), though it should be.
--	---

7 Malfunctions

7.3.3 Technical alarm

	This alarm is triggered if a traffic flow interruption has lasted too long or if a technical error has been detected. A reset is required to deactivate this alarm. A ringtone sounds at regular intervals as a reminder.
---	---

7.3.4 Intrusion alarm

	This alarm is triggered if someone tries to cross the system in the opposite direction and the entrance door does not close within a reasonable time. To deactivate this alarm, a reset must be performed.
---	--

7.3.5 Anti-pass-back alarm

	This alarm is triggered if someone tries to cross the facility in the opposite direction while the entrance door is closed or closes within a reasonable time. To deactivate this alarm, a reset must be performed.
---	---



NOTICE

To limit the number of false alarms, the system measures the time required for the entrance door to close and compares it to the reference time:

If the closure time is less than the reference time, an anti-pass-back alarm triggered.

If, on the other hand, the time is longer or equal to the reference time, an intrusion alarm triggered.

This reference time has present in the factory using very precise closing speed data, so it is important not to modify it!

7.3.6 The difference between anti-passback and intrusion



NOTICE

If the sensors detect a person entering the FlipFlow in the wrong direction when the entrance door is not closed, a (false) alarm is triggered. To limit the number of false intrusion alarms, the system measures the time required for the entrance door to close and compares it with the reference time.

If the closure time is less than the reference time, an anti-passback alarm is triggered.

If, on the other hand, the closure time is equal to or even longer than the reference time, an intrusion alarm is triggered.



NOTICE

This reference time is pre-set in the factory using a specific closing speed, so modifying it is prohibited!

8 Taking out of service and disposal

8.1 Decommissioning

When shutting down or taking out of service, the system is disconnected from the mains supply and any existing battery is unplugged.



NOTICE

After each temporary shutdown a new commissioning must be carried out.

8.2 Dismantling and disposal



NOTICE

All machine parts must be sorted by type of material and disposed according to local regulations and guidelines.



NOTICE

The door systems can be completely disassembled in reverse order.

The installation mainly consists of the following materials:

Aluminum:

- Linking profiles
- Gearbox, Drive panel
- Door leaves profiles and side profiles
- Various profiles and small parts

Steel / iron parts:

- Stainless steel casing, Floor panel, Box recess for floor installation
- Optional spacer or reinforcement profiles
- Gear components, springs
- Various small parts like fittings, covers, linking parts, etc.

Glass:

- Door leaves and side panels

Various electronic and electromechanical components:

- Sensors, control, and operator components
- Batteries and rechargeable batteries

Various plastics:

- Rollers
- Cable clips, coupling and linking parts
- Sealing profiles
- Casing of electromechanical components and sensors



Your global partner for entrance solutions